

HVAC CONTROLS

for system integrators



RTU

ROOFTOP UNITS

VAV



HUMIDIFIERS

FAN COIL



HEAT PUMPS

ELECTRIC HEATERS



neptronic[®]

neptronic.com



Proven integration with



Overview

Neptronic features a wide range of BTL listed BACnet MS/TP or Modbus networked controllers that have proven integration with several BMS systems on multiple sites around the world. Neptronic networkable controllers offer flexibility and simplicity within any integration strategy to provide:

- ▶ Seamless integration and interoperability
- ▶ Real-time information management and control
- ▶ Lower costs and higher value
- ▶ Diverse control strategies
- ▶ Higher energy conservation

Save Time On Integration, Installation and Commissioning

Neptronic networkable controllers feature some or all of the following features and benefits.



Two MAC Address Configuration Methods

Set MAC address via user friendly menu on thermostat or locally on unit via DIP switches.



Firmware Upgrade via BACnet

Upgrade the device in the field via BACnet. Initiate the upgrade during normal operation and choose when to restart the system.



Auto Configuration and Detection

The controller automatically configures its device instance to a default value + MAC address. The controller automatically configures its baud rate by detecting the network speed upon connection.



Programming Schedules

Determine occupancy in advance for 7 days with up to 6 events per day. Avoid constant monitoring and save energy.



Copy Configuration

Copy the controller's entire configuration and broadcast it to other controllers of the same type on the same network.



Automatic Update of Changed Values

Enable subscription to update changed values automatically. Avoid regular polling of values, reduce traffic and transmit faster.



BACnet Objects

Multiple BACnet Objects per controller enable you to read/write information as you monitor and trend status of operation, alarms and schedules.



Service Display

If you are searching for a specific device, enabling the service mode will flash the device to easily locate the device

UMCP Frederick Hall, Maryland (USA)



AUTOMATEDLOGIC

370 TFCB
wall mount controllers

NG Teng Fong General Hospital (Singapore)



Johnson Controls

3000 EVCB controllers

Rashid Hospital, Dubai (UAE)



Honeywell

240 EVCB controllers

Princess Noura University, Saudi Arabia



Schneider Electric

16000 EFCB controllers

Palm Tower, Qatar



TREND

1600 EVCB controllers

Wilson project, Sidney, OHIO (USA)



Thompson Tractor Company Alabaster, Alabama (USA)



BUILDINGLOGIX

65 EVCB controllers

International Civil Aviation Organization (ICAO) Montreal (Canada)



Delta

1100 EVCB controllers

Motorola, Israel



Delta

850 EFCB controllers

University of Quebec in Montreal (Canada)



Delta

580 Points EFCB controllers

Tiong Bahru Plaza, Singapore



TRANE

360 TUCB24 controllers

niagara

ALERTON

TRANE

Reliable
CONTROLS

Honeywell

ABB

YASKAWA

AUTOMATEDLOGIC

DEOS
controls

DOUGLAS

Delta

Schneider
Electric

VYKON
SYSTEMS

BUILDINGLOGIX

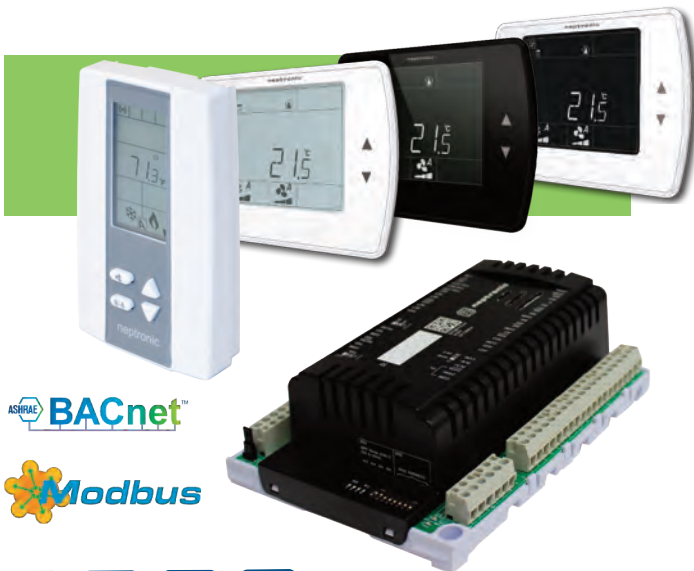

ASHRAE **BACnet™**

Modbus



Fan coil unit controller (EFCB) with Digital Room Sensor (TDU/TFL)

Choose your Digital Room Sensor model

Inputs

DI4

4 Digital*

AI6

6 Analog*



24Vac
120/240Vac

Outputs

BO8

4 TRIACs
Up to 4 Digital*

AO4

4 Analog*



1,2 or 3* Speed
or ECM

Communication

BAC

BACnet
MS/TP

Mod

Modbus
RTU Slave



Room Sensor
3 Wires (Digital)

*Configurable

Product	Model	Type	Extra 3A Relay
Fan Coil Controllers	EFCB10TU2	24Vac	2
	EFCB10TU4		4
	EFCB11TU2	120Vac	2
	EFCB11TU4		4
	EFCB12TU2		2
	EFCB12TU4		4
Middle East and Asian Markets	EFCB12T-OE1	240Vac	0
	EFCB12TU2-OE1		2
	EFCB12TU4-OE1		4

Controller (EFCB)

- Real Time Clock (RTC) with 24 hour backup
- Configurable PI (Proportional-Integral) function
- Selectable proportional control band and dead band
- Independent cool/heat setpoint for NSB/OCC mode
- Selectable internal or external temperature sensor (10KΩ)
- Change over by contact or external temperature sensor
- Freeze protection
- BACnet MS/TP or Modbus communication (selectable)
- BACnet scheduler
- Firmware upgradeable via BACnet

Applications

- Fan Coil Units
- 2 pipes or 4 pipes





● TDU10 ● TDU40 ○ TDU70

Horizontal Models	Temp	RH	CO2
● TDU10-100 ● TDU40-100 ○ TDU70-100	•		
● TDU10-101 ● TDU40-101 ○ TDU70-101	•	•	
● TDU10-102 ● TDU40-102 ○ TDU70-102	•	•	•
● TDU10-103 ● TDU40-103 ○ TDU70-103	•		•

Universal Digital Room Sensor (TDU)

- Built-in temperature sensor and optional humidity and CO2 sensors (see selected models)
- Built-in light level sensor
- 3.5" LCD display
- Slim design
- Universal wall-mount design
- Used to configure and operate the EVCB VAV controllers and EFCB Fan Coil controllers
- Selectable internal or external temperature sensor (10 KΩ)
- Three wire connection between thermostat and controller
- Selectable Fahrenheit or Celsius scale
- Network service port via on-board mini USB connector
- Approximate size 127mm x 82mm x 15mm (5" x 3.25" x 0.6")



Digital Room Sensor (TFL)

Model	Temperature	Humidity	Type
TFL54	•		3x3
TFL24	•		2x4
TFLH24-INT	•	Internal	2x4
TFLH24-EXT	•	External	2x4

- Backlit LCD with simple icon and text driven menus
- Select thermostat's default display
- BACnet service port via on-board mini USB connector
- Selectable Fahrenheit or Celsius scale
- Manual night set back or no occupancy override
- Multi level lockable access menu
- 3-wire connection to controllers
- Used to configure and operate EFCB Fan Coil Controllers

TFCB24 & TFHB24



Fan Coil Wall Mount Controller



Combination fan coil controller and room thermostat.
Run control wires directly to TFC unit.

Inputs

DI1	AI2	
1 Digital (occ sensor)	2 Analog (sensors)	24 Vac

Outputs

BO3	AO3	
3 TRIACs (2 or 4 pipe, local reheat)	3 Analog	1,2 or 3* Speed or ECM

Communication

BAC
BACnet MS/TP
<i>*Configurable</i>

BACnet Models

Model	Internal Humidity Sensor	Ext. Humidity Sensor (SHC80 Included)
TFCB24F3XYZ1	-	-
TFHB24F3XYZ1	-	Yes
TFHB24F3XYZ2	Yes	-

Stand-Alone Models

Model	Internal Humidity Sensor	Ext. Humidity Sensor (SHC80 Included)	Scheduler
TFC24F3XYZ1	-	-	-
TFC24F3XYZ3	-	-	Yes
TFH24F3XYZ1	-	Yes	-
TFH24F3XYZ2	Yes	-	-

Main Features

- Applications: Fan coil units (2 or 4 pipes)
- Precise temperature control with programmable PI function
- Selectable internal or external temperature sensor
- Changeover by contact or external temperature sensor
- Freeze protection
- BACnet communication
- External humidity sensor (select models)
- Dehumidification sequence (select models)
- Backlit LCD with simple icon and text driven menus
- Selectable Fahrenheit or Celsius scale
- Manual no occupancy override
- Multi level lockable access menu



TFC54 & CCC



Fan Coil Wall Mount Controller



Stand-Alone Models (TFC54)

Model	On-off (TRIAC)	Analog (0-10Vdc)
TFC54F3Y1	Yes	-
TFC54F3X1	-	Yes

Main Features

- Configurable inputs and outputs:
 - 2 TRIAC outputs or 2 analog outputs (depends on model)
 - 3 fan speed digital outputs (dry contacts)
 - 2 inputs
- Selectable internal or external temperature sensor
- Changeover by contact or external temperature sensor
- Selectable proportional control band and dead band
- 24Vac operation
- Selectable Fahrenheit or Celsius scale
- Manual night set back override
- Multi level lockable access menu



Relay Interface Board (CCC)

- 240/120 Vac
- 3, 4 or 5 contacts, 7A
- Also available in a metal box with secure 4-point mounting
- LED indication of relay status
- Fused 240/120 Vac & 24 Vac circuits

Inputs

DI2

2 Digital
(occ sensor)

24 Vac

24 Vac

Outputs

BO2

2 TRIACs
(TFC54F3Y1)

AO2

2 Analog
(TFC54F3X1)

1, 2 or 3* Speed

1, 2 or 3* Speed

Communication

BAC

BACnet
MS/TP

*Configurable

Applications

- 2 pipe systems
- 4 pipe systems

Applications

- Ideal for fan coil applications where 240/120 Vac equipment must be controlled by a 24Vac thermostat controller
- Designed to operate with TFC series thermostat



ASHRAE **BACnet™**

Modbus



VAV Unit Controller

VAV unit controller (EVCB) with Digital Room Sensor (TDU/TRL)

*Choose your own Digital Room Sensor model

VAV Unit Controllers

Model	TRIACs	Pressure Type	Feedback	Fan Powered Box
EVCB14NIT0S	0	Indep.	-	-
EVCB14NIT2S	2	Indep.	-	-
EVCB14NIT4S	4	Indep.	-	Yes
EVCB14NDT4S	4	Dep.	-	Yes
EVCB14NIT0SF	0	Indep.	Yes	-
EVCB14NIT4SF	4	Indep.	Yes	Yes

Without Motor

Model	TRIACs	Pressure Type	Feedback	Motor
EVCB14NIT4X	4	Indep.	-	External

Applications

- Single duct, cooling only and/or heating
- Up to 4 stage reheat and/or cool
- Up to 4 On/Off heat and/or cool
- Up to 4 time proportioned (TPM) heat or reheat
- Up to 2 analog (0-10Vdc) reheat and/or cool
- Up to 2 floating heat and/or cool
- Pressure dependent or pressure independent
- With or without auto changeover
- Supply/exhaust (requires an additional EVC)



Inputs

DI2 2 Digital*	AI2 2 Analog*	 Pressure Sensor (select models)	 24Vac
--------------------------	-------------------------	---	------------------

Outputs

BO4 Up to 4 TRIACs	AO2 2 Analog*
------------------------------	-------------------------

Communication

BAC BACnet MS/TP	Mod Modbus RTU Slave	 Room Sensor 3 Wires (Digital)
-------------------------------	-----------------------------------	---

*Configurable

Controller (EVCB)

- Built-in actuator, 70 in.lb. (8Nm) (select models)
- On board differential pressure sensor (select models)
- Simple air balancing and commissioning via thermostat
- Automatically sets operation mode to pressure dependent or independent based on the presence of air flow
- Configurable PI (Proportional-Integral) function
- Independent, configurable proportional control band and dead band per ramp
- Selectable internal or external temperature sensor (10KΩ)
- Thermostat with on-board CO₂ sensor or external CO₂ sensor with integrated logic
- Changeover by contact or external temperature sensor
- Potentiometer feedback for increased precision of actuator position (select models)
- Real time clock (RTC) with 24-hour backup
- BACnet MS/TP or Modbus communication (selectable)

TDU/TRL



LCD Digital Room Sensors



● TDU10

● TDU40

○ TDU70

Horizontal Models	Temp	RH	CO2
● TDU10-100 ● TDU40-100 ○ TDU70-100	•		
● TDU10-101 ● TDU40-101 ○ TDU70-101	•	•	
● TDU10-102 ● TDU40-102 ○ TDU70-102	•	•	•
● TDU10-103 ● TDU40-103 ○ TDU70-103	•		•

Universal Digital Room Sensor (TDU)

- Built-in temperature sensor and optional humidity and CO2 sensors (see selected models)
- Built-in light level sensor
- 3.5" LCD display
- Slim design
- Universal wall-mount design
- Used to configure and operate the EVCB VAV controllers and EFCB Fan Coil controllers
- Selectable internal or external temperature sensor (10 KΩ)
- Three wire connection between thermostat and controller
- Selectable Fahrenheit or Celsius scale
- Network service port via on-board mini USB connector
- Approximate size 127mm x 82mm x 15mm (5" x 3.25" x 0.6")



Digital Room Sensor (TRL)

Model	Temperature	RH	CO2	Type
TRL54	•			3x3
TRL24	•			2x4
TRLG24	•		•	2x4
TRLH24	•	•		2x4
TRLHG24	•	•	•	2x4

- Backlit LCD with simple icon and text driven menus
- Built-in, self-calibrating, non-dispersive infrared (NDIR) CO₂ sensor (select models)
- Select thermostat's default display
- BACnet service port via on-board mini USB connector
- Selectable Fahrenheit or Celsius scale
- Manual night set back or no occupancy override
- Multi level lockable access menu
- 3-wire connection to controllers
- Used to configure and operate EVCB VAV Controllers

TRO24/TRO54



VAV Wall Mount Controller



TRO24



VAV Wall Mount Controller

Combination VAV controller and room thermostat.
Run control wires directly to TRO unit.

BACnet Model

Model	Options
TROB24T4XYZ1	BACnet

Stand-Alone Models

Model	Options
TRO24T4XYZ1	-
TRO24T4XYZ3	Scheduler
TRO24-EXT1	Extended setpoint range

Applications

Ideal for existing installations and retrofits that already have an actuator mounted on the VAV box.



TRO54

Stand-Alone Models

Model	Analog outputs	TPM/Digital outputs	Sensor inputs
TRO5404	4	1 TPM	2
TRO54P3X1	2	3 Digital	2

Inputs

AI3	
3 Analog*	24 Vac

Outputs

BO4	AO2
4 TRIACs*	2 Analog*

Communication



BACnet
MS/TP

*Configurable



Main Features

- Programmable PI function
- Selectable proportional control band and dead band
- Pressure sensor input with air flow program
- Selectable internal or external temperature sensor
- Changeover by contact or external temperature sensor
- Freeze protection
- Backlit LCD with simple icon and text driven menus
- Selectable Fahrenheit or Celsius scale
- Manual Night set back override
- Multi level lockable access menu and setpoint

Main Features

- 24Vac operation
- Backlit LCD with simple icon and text driven menus
- Selectable Fahrenheit or Celsius scale
- "Night Set Back" mode with manual override
- Multi level lockable access menu and setpoint
- Selectable internal or external temperature sensor
- Selectable proportional control band

TUCB/TUHB



Universal Wall Mount Controller

- Packaged AC Rooftop Units
- Heat Pumps
- Fan Coils



Wall Mount Universal Controller

Combination controller and room thermostat.
Run control wires directly to TUCB unit.

Models

Model	DI*	AI*	BO*	AO*	Sensor
TUCB24C6X2	2	2	6	2	Temp.
TUHB24C6X2	2	2	6	2	Temp. / Hum.

*fully configurable for universal applications

Universal Applications

- Heat pumps
- Packaged AC rooftop units
- Fan coils
- Humidity control
- CO₂ alarms
- Other heating/cooling equipment

Inputs

DI2	AI2	
2 Digital	2 Analog* (Universal)	24 Vac

Outputs

DO6	AO2	
6 Digital*	2 Analog*	1, 2 or 3* Speed (BO3-BO6) or ECM (AO2)

Communication

BAC	Mod
BACnet MS/TP	Modbus RTU Slave

*Configurable

Main Features

- Applications: Heat pump, humidity control, CO₂ alarms, or general unit controller
- Precise temperature control with programmable PI function
- Selectable internal or external temperature sensor
- External humidity sensor input
- Built-in humidity sensor (TUHB models only)
- Dehumidification sequence compensated by auto activation of reheat output
- Changeover by contact or external temperature sensor
- Compressor anti-cycling delay (configurable)
- Low limit set protection (10°C/50°F)
- Freeze protection
- Occupancy and Night Set Back (NSB) mode
- Real time clock (RTC) with 24-hour backup
- BACnet MS/TP or Modbus communication (selectable)
- 7-day BACnet schedule
- Backlit LCD with simple icon and text driven menus
- Selectable Fahrenheit or Celsius scale
- Manual no occupancy override
- Multi level lockable access menu and setpoint



ARO/AROB



IAQ Wall Mount Controller

With IAQ
Sensors



On-board Sensors

- Temperature sensor (°C/°F)
- Humidity sensor (%RH), select models
- Carbon dioxide sensor (CO₂), select models
- VOC sensor (volatile organic compounds), select models
VOC are volatile organic chemicals (indoor air pollutants)

Stand-Alone Models

Model	Temp	RH	CO ₂	VOC
ARO24T	✓			
ARO24TH	✓	✓		
ARO24TGH	✓	✓	✓	
ARO24TGVH	✓	✓	✓	✓

Networkable Models

Model	Temp	RH	CO ₂	VOC
AROB24T	✓			
AROB24TH	✓	✓		
AROB24TGH	✓	✓	✓	
AROB24TGVH	✓	✓	✓	✓

Inputs

AI1	BI1
1 Analog	1 Binary*

Outputs

BO2	AO2	
2 Binary*	2 Analog*	ECM

Communication

BAC	Mod
BACnet MS/TP	Modbus RTU Slave

*Configurable

Main Features

- Built-in application profiles to automatically configure the controller for the selected application.
- Up to 4 simultaneous control loops capable of controlling, in real time:
 - Humidification and Dehumidification
 - Heating and Cooling
 - CO₂ levels
 - VOC levels
- Integrated ECM fan control mode
- Displays temperature, %RH, CO₂, VOC, and setpoints
- Display or hide all the required access for user interaction
- Backlit LCD with simple icon and text-driven menus
- Selectable Fahrenheit or Celsius scale
- Precise temperature control with programmable P function
- Independent cool and heat setpoint for No Occupancy
- Configurable proportional control band and dead band

HROB20



Humidity Control Wall Mount Controller



Wall Mount Humidity Controller

Combination controller and room humidistat.
Run control wires directly to HROB unit.

Applications

- Neptronic SKR, SK300, SKE, and SKG humidifiers
- Other humidification and dehumidification applications

Ramps

- **LSS: External Demand Low Signal Selector**
Compares selected input signals to select the lowest signal.
- **AER: External Humidity Sensor Averaging**
Calculates an average of selected input signals
- **DUC: Duct Supply Input**
Two PID loops and a zero/span to smooth out the demand signal
- **DED: External Demand Signal**
Control using an external demand of 0-10Vdc or 2-10Vdc
- **HIL: High limit**
Compares the demand of the room humidity PID loop with the duct/high limit PID loop and applies the lower of the two.

Inputs

DI1

1 Digital
(alarm status)

AI3

3 Analog



24 Vac

Outputs

DO2

2 Digital

AO4

4 Analog

Communication

BAC

BACnet
MS/TP

*Configurable

Main Features

- BACnet MS/TP (stand-alone model HRO20 also available)
- 4 analog outputs and 2 dry contact outputs
- External humidity sensor input
- Window or external temperature sensor input
- Alarm status and low signal selector input
- Independently configure PID on humidify & dehumidify ramps
- Adjustable setpoint with auto reset from external sensor
- Multi level lockable access menu, setpoint and control mode
- Backlit LCD with simple icon and text driven menus
- Selectable Celsius or Fahrenheit scale
- Humidification and dehumidification indicator





Dual Pro I/O Board

Input and output expansion board (CMMB)

Models

Type	Model	Buttons	Inputs	Outputs
Exp. Board	CMMB106	-	10	10
Thermostat	STLD24A	Fan & heat-cool	1	-
Thermostat	STLD24B	Fan & °F/°C	1	-

Applications

The CMMB series extends your BACnet or Modbus network when your application requires additional inputs and outputs on a physical controller. The CMMB provides simple expansion of a new or existing controller and reduces unnecessary costs of additional components.

Connected directly to the CMMB106 via Modbus, the STLD24 Modbus RTU LCD Thermostat provides internal and external temperature sensors, LCD display and operational commands without using up a BACnet address.

Inputs

DI2

2 Digital*

AI8

8 Analog*
(universal)



24 Vac

Outputs

DO6

6 Digital*

AO4

4 Analog*

SW

10 Override
Switches

Communication

BAC

BACnet
MS/TP

Mod

Modbus
RTU Slave

*Configurable

Expansion Board (CMMB)

- BACnet MS/TP or Modbus communication (selectable)
- 10 inputs and 10 supervised outputs
- 10 override switches to manually control each output
- LED status indication of each input and output
- DIN rail mounting

Room Thermostat (STLD)

- User Interface fully customizable via Modbus RTU
- Backlit LCD with simple icon and text driven menus
- Built-in temperature sensor
- External temperature sensor input (10 KΩ)
- Selectable Fahrenheit or Celsius scale
- Set Modbus RTU baud rate via thermostat menu (9600, 19200, 38400 or 57600 bps)
- Set Modbus RTU address via thermostat menu or via DIPswitch

CMMB IP



Ethernet I/O Module Expansion Controller

NEW

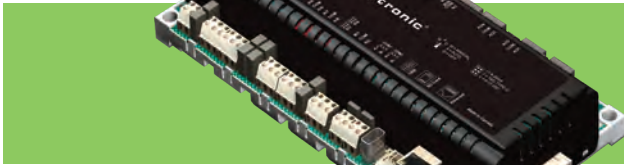

Models

Model	Router	Display	Communication Ports	
			BACnet Ports	Modbus Ports
CMMB-IP	-	-	1	1
CMMB-IP-L	-	Yes	1	1
CMMB-IP-R	Yes	-	1	1
CMMB-IP-RL	Yes	Yes	1	1
CMMB-IP-R1B	Yes	-	1	-
CMMB-IP-R2B	Yes	-	2	-
CMMB-IP-RL1B	Yes	Yes	1	-
CMMB-IP-RL2B	Yes	Yes	2	-

Features

Power & Communication

- 24Vac or 24Vdc supply
- Up to 2 RS-485 communication ports for BACnet MS/TP or Modbus RTU
- BACnet IP/Ethernet or Modbus TCP/IP
- Set network settings via embedded WEB server
- Provision for I/O expansion modules
- Router functionality (optional)

10 Inputs

- 2 binary inputs
- 8 universal inputs

10 Outputs

- 6 binary outputs
- 4 analog outputs
- Supervised manual override of outputs via local web page or local dip switches

Other

- SD card slot for updates
- USB port for 5 Vdc power supply
- RJ45 Ethernet connection for IP and WEB services

Inputs

BI2

2 Binary Inputs*

AI8

8 Analog* (universal)

Outputs

BO6

6 Binary*

AO4

4 Analog*

SW

10 Override Switches

Communication

BAC

BACnet MS/TP, IP

Mod

Modbus RTU Slave, TCP/IP

IP

Ethernet

Network Communication

BACnet MS/TP

- MS/TP @ 9600, 19200, 38400 or 76800 bps
- Automatic baud rate detection
- Automatic device instance configuration

BACnet IP/Ethernet

- All IP / Ethernet configuration via on board WEB page
- Display device status including each available data point, in addition to the BACnet object interface.
- Supports DHCP or fixed/static addressing

Modbus

- Modbus @ 9600, 19200, 38400 or 57600 bps
- RTU Slave, 8 bits (configurable parity and stop bits)
- Connects to any Modbus master

Modbus TCP/IP

- Connects to any Modbus TCP/IP master controller

CMMB1322

I/O

Mini I/O Module Expansion Controller



ASHRAE BACnet™



Remote BACnet I/O Board

Input and output expansion board (CMMB)

Models

Type	Network	Inputs	Outputs
CMMB1322	BACnet MS/TP	2	2

Main Features

- BACnet MS/TP
- 2 inputs and 2 supervised outputs
- 2 override switches to manually control each output
- 120Vac or 240 Vac selectable power input
- 2 auxiliary outputs (24Vdc / 24Vac)

Inputs

AI2

2 Analog*
(Universal)



120 or 240 Vac
(selectable)

Outputs

BO2

2 Binary*

SW

2 Override
Switches



24Vdc and 24Vac
(aux. output)

Communication

BAC

BACnet
MS/TP

*Configurable

SMBR



BACnet Router



Models

Model	Description	Devices
SMBR1	1-Port BACnet	Up to 32
SMBR2	2-Port BACnet	Up to 64
SMMR1	1-Port Modbus	Up to 32



Main Features

- One page, set-and-forget configuration and unique network discovery capabilities minimize installation time
- Up to 32 or 64 BACnet devices without the use of additional line drivers
- DeviceFind™ discovery feature: enables you to discover BACnet devices connected to the router with one push of a button (minimizes time required for successful commissioning)
- Lowest cost per connected MS/TP device
- Lowest response time per connected MS/TP device

SARB



Networkable IAQ Room Sensors



BACnet™

Modbus



Models

Model	Temp	RH	CO ₂	VOC
SARB24T	✓			
SARB24TH	✓	✓		
SARB24TG	✓		✓	
SARB24TV	✓			✓
SARB24TGH	✓	✓	✓	
SARB24TGVH	✓	✓	✓	✓

Main Features

- 2 inputs and 4 outputs commandable via network
- Enthalpy and dew point calculations (available via network)
- Display or hide all the required access for user interaction
- Backlit LCD with simple icon and text-driven menus
- Selectable Fahrenheit or Celsius scale

Inputs

AI1	BI1	
1 Analog	1 Binary	24 Vac/ 24 Vdc

Outputs

BO2	AO2
2 Binary*	2 Analog*

Communication

BAC	Mod
BACnet MS/TP	Modbus RTU Slave

*Outputs commandable via network

- BACnet® MS/TP or Modbus (selectable via menu)
- Select MAC address via menu or via network
- Automatic baud rate detection
- Network service port via on-board mini USB connector

SAR



IAQ Room Sensors



Models

Model	Temp	RH	CO ₂	VOC
SAR24GH		✓	✓	
SAR24GV			✓	✓

Main Features

- CO₂ sensor feedback output (**AO1**)
- CO₂ warning and alarm level outputs (**BO1** and **BO2**)
- Humidity or VOC sensor feedback output (**AO2**)
- Input voltage 24Vac or 24Vdc



STC8: Duct Mount Temperature Sensor

- High accuracy and stability
- Fast thermal response
- Epoxy encapsulated sensor
- Extended durability
- Resistor/Temperature Curve
 - "G" matched (STC8-11, 10K Ω)
 - "A" matched (STC8-13, 3.3 K Ω)
- Compatible with Nepronic controllers, such as TRO, TFC, EFC and EVC

STC8-11	10K Ω
STC8-13	3.3K Ω
STC80X	Analog



STR1: Wall Mount Temperature Sensor

- Available with 10K Ω or 3.3K Ω thermistor
- High accuracy and stability
- Negative Temperature Coefficient (NTC)
- Compatible with Nepronic products

STR1-11	10K Ω
STR1-13	3.3K Ω



STS3: Wall Mount Thermostat

- Built-in temperature sensor
- Adjustable setpoint with mechanical lock
- Sensor type: 10K Ω or 3.3K Ω
- Scale: Celsius or Fahrenheit

STS3-11F	10K Ω °F
STS3-11C	10K Ω °C
STS3-13F	3.3K Ω °F
STS3-13C	3.3K Ω °C



ITO3: Wall Mount Setpoint Station

- Adjustable setpoint with mechanical lock
- Scale: Celsius or Fahrenheit
- Compatible with STC8-13 duct mounted temperature sensor in installations with Nepronic series duct heaters

ITO3-F	°F
ITO3-C	°C

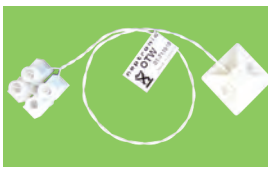

OTW / SHW: Window Temperature Sensor

- 10K Ω (SHW0-11) or 3.3K Ω (OTW) temperature sensor
- Self adhesive: sticks directly on window
- SHW0-11 compatible with HROB20 humidistats
- OTW compatible with SKR humidifiers

OTW	3.3K Ω
SHW0	10K Ω



STI1-11: Immersion Water Temperature Sensor

- 10K Ω Type III Thermistor
- Immersion type temperature sensor
- High accuracy and stability
- Fast thermal response
- Double encapsulation sensor eliminates moisture infiltration
- Machined 5 Brass thermowell
 - ABS plastic enclosure
 - Quick snap latch
- Hinged cover without screws
- Includes 316 stainless steel 3/4" x 1/2" t-tap fitting

STI1-11	10K Ω
---------	--------------



STP: Strap-On Water Temperature Sensor

- 10K Ω Type III Thermistor
- Designed for fan coil 2 pipe changeover applications
- High accuracy and interchangeability over a wide temperature range
- Sensor's higher resistance output compares to platinum Resistance Temperature Detectors (RTD)
- Sensitive to non-polarity
- Temperature range: -40°C to 150°C (-40°F to 302°F)
- Zinc-plated steel enclosure (STP7-11) or ABS plastic enclosure (STP1-11)

STP7-11	Metal
STP1-11	Plastic

Sensors



Humidity



SHC80: Duct Mount Humidity Sensor

- Duct mounted humidity sensor
- Built-in temperature sensor
- 2 analog outputs (0 - 10 Vdc)
- Can be installed in association with Neptronic room humidistat (HROB20)
- Status LED



Window Temperature Sensor

- 10K Ω (SHW0-11) or 3.3K Ω (OTW) temperature sensor
- Self adhesive: sticks directly on window
- SHW0-11 compatible with HROB20 humidistats
- OTW compatible with SKR humidifiers



SHR10: Wall Mount Humidity Sensor

- Wall mounted humidity sensor
- Built-in temperature sensor
- Plastic cover for wall mount installation
- 2 analog outputs (0 - 10 Vdc)
- Can be installed in association with Neptronic room (HROB20) humidistat or directly to the Neptronic SK300 / SKE Series Steam humidifier (rev 3.3)
- High accuracy and stability



HRC20: Room Humidistat

- Humidity setpoint dial (10-60 %RH)
- Built-in humidity sensor
- 24Vac or 24Vdc
- 1 dry contact output

Sensors



Pressure



Model	Pressure Range
SPC 0.1	0 to 0.1" w.c.[25 Pa]
SPC 1.0	0 to 1.0" w.c.[250 Pa]
SPC 2.0	0 to 2.0" w.c.[500 Pa]
SPC 5.0	0 to 5.0" w.c.[1245 Pa]

SPC: Static Pressure Controller

- LCD Display
- Simple installation and configuration
- Displays actual pressure reading
- Adjustable setpoint and dead band
- Adjustable response speed
- Selectable output signal
- Direct or reverse action outputs
- Fully calibrated
- Real-time pressure output for remote monitoring

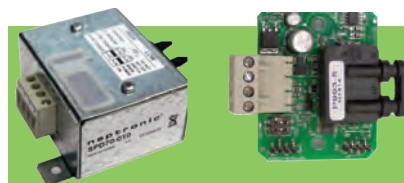

SPD70
(with metal enclosure)

SPD00
(PCB only)

Model	Pressure Range	Enclosure
SPD00-010	0-1" w.c.[250 Pa]	PCB only
SPD70-010	0-1" w.c.[250 Pa]	Metal enclosure
SPD00-020	0-2" w.c.[500 Pa]	PCB only
SPD70-020	0-2" w.c.[500 Pa]	Metal enclosure
SPD00-050	0-5" w.c.[1245 Pa]	PCB only
SPD70-050	0-5" w.c.[1245 Pa]	Metal enclosure

SPD: Static Pressure Differential Transducer

- Small footprint
- Simple and easy to install
- Selectable output signal (0-10 or 2-10 Vdc & 4-20 or 0-20mA)
- High flow impedance in the range of tens to hundreds of kPa

Accessories

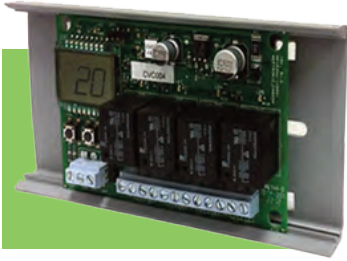

Model	Relays
CVC002	2
CVC004	4

CVC

- 24Vac or 24 Vdc supply
- 2 or 4 SPDT relays (staged or sequenced operation)
- Voltage or current input
- Menu-driven LCD
- Adjustable relay setpoint, hysteresis and activation delay
- Input signal management (loss of signal)
- Displays input voltage or current
- LED status indication of each relay
- Snap Track mounting
- Non-strip, raising clamp terminals



MEP: Manual Electronic Positioner

- Variable or fixed position controller
- Simple installation
- Wall or panel mounted
- Stainless steel faceplate



SCC80: Changeover Control Sensor

- 24Vac or 24 Vdc supply
- Sensor operation temperature up to 176°F [80°C]
- Fast response, excellent accuracy
- SPDT output relay
- No adjustments required (pre-calibrated)
- Built-in mounting tabs and mounting screws supplied for easy installation
- Status LED



Comes with male/female collar

Total connector pressure output is routed behind probe to minimize pressure loss and noise

Bullet shaped averaging chamber for low pressure loss and noise

3/16" Static pressure signal amplification ring

Equal area total pressure port

Static pressure connector output routed behind probe to minimize loss and noise

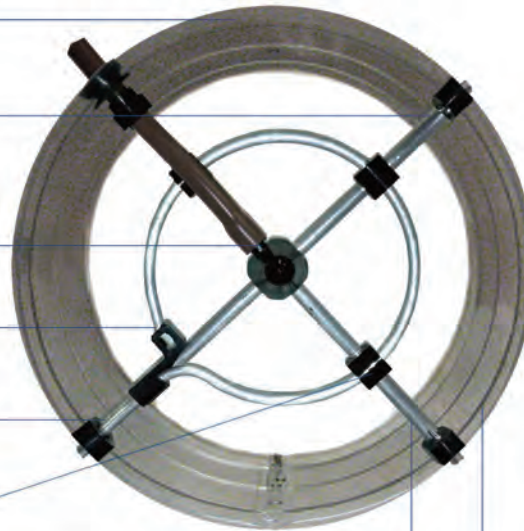

1/4" Total pressure averaging probes

22 gauge galvanized steel



Air Flow Stations

Mechanically amplifies the differential pressure signal making air velocity measurement in VAV boxes possible.

Main Features

- Mechanical amplification of differential pressure signal
- 2 outputs (total pressure and static pressure)
- Advanced design minimizes pressure loss and white noise

Models

Description	CF-06	CF-08	CF-10	CF-12	CF-14	CF-16
Inlet Diameter	6" (15.25 cm)	8" (20.30 cm)	10" (25.40 cm)	12" (30.50 cm)	14" (35.56 cm)	16" (40.64 cm)
Area	0.196 ft ² (0.018 m ²)	0.349 ft ² (0.032 m ²)	0.545 ft ² (0.050 m ²)	0.785 ft ² (0.073 m ²)	1.069 ft ² (0.099 m ²)	1.396 ft ² (0.130 m ²)
Velocity Constant	2812 FPM (14.3 m/s)	2740 FPM (13.9 m/s)	2841 FPM (14.4 m/s)	2822 FPM (14.3 m/s)	2666 FPM (13.5 m/s)	2837 FPM (14.4 m/s)
Velocity Pressure Constant	0.49	0.47	0.50	0.49	0.45	0.50
K Factor	552 CFM (261 l/s)	956 CFM (451 l/s)	1550 CFM (732 l/s)	2216 CFM (1046 l/s)	2850 CFM (1345 l/s)	3961 CFM (1869 l/s)
Amplification Factor F	2.60	2.30	2.30	2.15	2.15	2.10
Total Pressure Ports (ASHRAE Standard 62)	12	12	16	16	20	20
Velocity Range	300 to 3,000 FPM (1.5 to 15.2 m/s)					
Temperature Range	-40°C to 80°C (-40°F to 176°F)					
Materials	Aluminum & PC/ABS					



Actuators

Up to 70in.lb

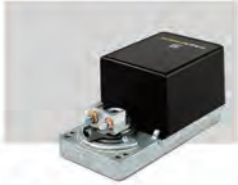

D-B-S

▶ 35in.lb (4Nm) to 70in.lb (8Nm)

Up to 360in.lb



L-T-R

▶ 140in.lb (16Nm) to 360in.lb (40Nm)

Up to 4000in.lb

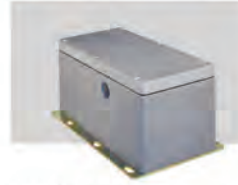

U & W

▶ 1800in.lb (200Nm) to 4000in.lb (450Nm)

FAST



B-T-R

▶ Running time of 1.5sec to 30sec

SMOKE DAMPER



BTX-LTX

▶ Rated at 250°F (121°C)

OUTDOOR



IP65

▶ High humidity and outdoor applications

LINEAR



A-M-V

▶ Zone and globe valve applications

Actuated Valves

CONTOURED PORT BALL



FULL PORT BALL



INDUSTRIAL BALL



BUTTERFLY



ZONE



GLOBE



RETRO FIT

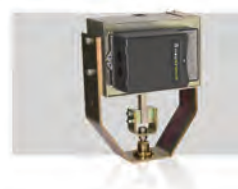



HECB Networkable Controller



Benefits

Save Energy

- Embedded and configurable energy conservation strategies
- Automatic or dynamic load shedding
- Limit electric heater consumption based on multiple variables
- Provides real-time temperature measures and power consumption data

Save Time

- View heater status and alarms remotely via network or thermostat
- Remote monitoring (status, alarms, diagnostics, and trending)
- Wall-mount remote user interface (view temperature, setpoint, heater status and alarms)

Integrate

- Integrate with BMS and intelligent buildings via BACnet MS/TP or Modbus
- Multiple BACnet/Modbus points to propel you towards the Internet of Things (IoT)
- Ensure better management of energy consumption for the future

Standard Features

- Accepts any industry standard input signal
- Quick and simple input signal selection via DIP switches
- Modulating, on/off, and/or up to 10 stages
- Real-time feedback output of heater capacity
- Automatic PID
- Remote feedback with TRL54 or TRL24 LCD thermostat (eliminates the use of expensive staged thermostats)
- Zero voltage crossing SSR
- Patented EAS Electronic Air Flow Sensors (US 7,012,223)

Network Communication

- BACnet MS/TP or Modbus RTU (selectable via DIP switch)
- Select MAC address via DIP switch or via network

BACnet MS/TP

- MS/TP @9600, 19200, 38400 or 76800 bps
- BACnet scheduler (up to 6 events)
- Firmware upgradeable via network
- COV (change of value)
- Copy and broadcast configuration to other HECB controllers via menu or network
- Automatic baud rate detection
- Automatic device instance configuration

Modbus RTU

- Modbus RTU @9600, 19200, 38400 or 57600 bps
- RTU Slave, 8 bits (configurable parity and stop bits)
- Connects to any Modbus RTU master

MANUFACTURER OF ■

- HVAC CONTROLS
- ELECTRIC ACTUATORS
- ACTUATED VALVES
- HUMIDIFIERS
- ELECTRIC HEATERS